

Petro Geoscience 1. IN SITU STRESSES IN SEDIMENTARY ROCKS (PART 1): MEASUREMENT TECHNIQUES

J. S. Bell

Volume 23, numéro 2, juin 1996

URI : https://id.erudit.org/iderudit/geocan23_2ser01

[Aller au sommaire du numéro](#)

Éditeur(s)

The Geological Association of Canada

ISSN

0315-0941 (imprimé)

1911-4850 (numérique)

[Découvrir la revue](#)

Citer cet article

Bell, J. S. (1996). Petro Geoscience 1. IN SITU STRESSES IN SEDIMENTARY ROCKS (PART 1): MEASUREMENT TECHNIQUES. *Geoscience Canada*, 23(2), 85–100.

Résumé de l'article

Ce rapport est le premier des deux qui présentent la recherche récente des contraintes in-situ dans les roches sédimentaires, et les applications de la géologie et du génie pétrolier de ces données. La partie première décrit et adresse les méthodes les plus populaires pour mesurer les contraintes contemporaines qui affectent les roches sédimentaires en termes de S_v (contrainte principale verticale), de S_{Hmin} (contrainte majeure horizontale) et de S_{Hmln} (contrainte mineure horizontale). Pour obtenir les grandeurs des contraintes, on peut examiner les diagraphies de densité (S_v), utiliser les fractures hydrauliques ou des essais de pression sous le sabot de cimentation (S_{Hmin}) aussitôt que les techniques analytiques exécutées sur des carottes (S_{Hmin} , S_{Hmjn}). Mortaiser les sondages offre une promesse pour les puits profonds (S_{Hmn} , S_{Hmln}), mais la technique n'est pas encore opérationnelle. Près de la surface, on peut déduire les orientations des contraintes (S_{Hmin} , S_{Hmln}) avec l'assistance d'un assortiment d'indicateurs géologiques, mais il est nécessaire de sélectionner les endroits avec précaution. Sous la surface, les orientations des contraintes principales sont fournies par les ovalisations des puits de forage (S_{Hmjn} , S_{Hmln}), des types particuliers de fractures des carottes (S_{Hmln} , S_{Hmini}), par le discage des carottes (S_{Hmln} , S_{Hmln}), par la dilatation des carottes (S_{Hmin} , S_{Hmin}), des fractures hydrauliques (S_{Hmn}) et aussi les tremblements de terre (S_{Hmln}). L'anisotropie acoustique et la séparation des ondes transversales indiqueront l'orientation des fractures microscopiques, mais les attitudes obtenues ne sont pas toujours en accord avec les axes des contraintes contemporaines. Toutes ces méthodes sont courantes, particulièrement dans l'industrie pétrolière.

Series

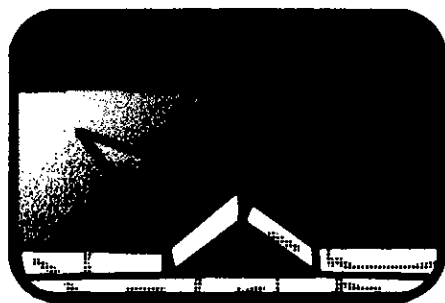

Petro Geoscience 1. IN SITU STRESSES IN SEDIMENTARY ROCKS (PART 1): MEASUREMENT TECHNIQUES

J.S. Bell
Geological Survey of Canada
3303 33rd Street NW
Calgary, Alberta T2L 2A7

SUMMARY

This paper is the first of two that review recent research involving *in situ* stresses in sedimentary rocks and the geological and petroleum engineering applications of these data. Part I describes and discusses the most commonly used methods for measuring today's rock stresses in sedimentary rocks, in terms of S_v (vertical principal stress), S_{Hmax} (larger horizontal principal stress) and S_{Hmin} (smaller horizontal principal stress). Stress magnitudes may be obtained from density logs (S_v), from hydraulic fracture tests and leak-off tests (S_{Hmin})

Editor's Note:

This paper is the first in a new series of review articles that will focus on the geoscience methodology used in the oil industry. Proposed topics include: petroleum geochemistry, stratigraphy, sedimentology, log analysis and reflection seismology, as well as some case histories.

as well as from core monitoring techniques (S_{Hmin} , S_{Hmax}). Borehole slotting holds promise for use in deep wells (S_{Hmin} , S_{Hmax}), but is not yet operational. Near-surface stress orientations (S_{Hmin} , S_{Hmax}) can be inferred from a variety of geological indicators, provided precautions are taken in selecting locations. Subsurface stress orientation data are provided by breakouts (S_{Hmin} , S_{Hmax}), specific types of core fractures (S_{Hmin} , S_{Hmax}) and core discing (S_{Hmax}), as well as by core expansion (S_{Hmin} , S_{Hmax}), hydraulic fractures (S_{Hmax}), drilling-induced fractures (S_{Hmax}), and earthquakes (S_{Hmax}). Acoustic anisotropy and shear wave splitting will indicate microfracture orientation, which may or may not coincide with contemporary stress axes. All these methods are in common use today, especially within the oil industry.

RÉSUMÉ

Ce rapport est le premier des deux qui présentent la recherche récente des contraintes *in-situ* dans les roches sédimentaires, et les applications de la géologie et du génie pétrolier de ces données. La partie première décrit et adresse les méthodes les plus populaires pour mesurer les contraintes contemporaines qui affectent les roches sédimentaires en termes de S_v (contrainte principale verticale), de S_{Hmin} (contrainte majeure horizontale) et de S_{Hmin} (contrainte mineure horizontale). Pour obtenir les grandeurs des contraintes, on peut examiner les diagraphies de densité (S_v), utiliser les fractures hydrauliques ou des essais de pression sous le sabot de cimentation (S_{Hmin}), aussitôt que les techniques analytiques exécutées sur des carottes (S_{Hmin} , S_{Hmin}). Mortaiser les sondages offre une promesse pour les puits profonds (S_{Hmin} , S_{Hmin}), mais la technique n'est pas encore opérationnelle. Près de la surface, on peut déduire les orienta-

tions des contraintes (S_{Hmin} , S_{Hmin}) avec l'assistance d'un assortiment d'indicateurs géologiques, mais il est nécessaire de sélectionner les endroits avec précaution. Sous la surface, les orientations des contraintes principales sont fournies par les ovalisations des puits de forage (S_{Hmin} , S_{Hmin}), des types particuliers de fractures des carottes (S_{Hmin} , S_{Hmin}), par le discage des carottes (S_{Hmin} , S_{Hmin}), par la dilatation des carottes (S_{Hmin} , S_{Hmin}), des fractures hydrauliques (S_{Hmin}) et aussi les tremblements de terre (S_{Hmin}). L'anisotropie acoustique et la séparation des ondes transversales indiqueront l'orientation des fractures microscopiques, mais les attitudes obtenues ne sont pas toujours en accord avec les axes des contraintes contemporaines. Toutes ces méthodes sont courantes, particulièrement dans l'industrie pétrolière.

INTRODUCTION

Major efforts have been made to measure crustal stresses in all sorts of geological environments in recent decades in order to determine how rocks are being squeezed today or, more prospectively, to map the configurations of contemporary local and regional stress regimes. Why would busy geoscientists in industrial and academic institutions take pains to acquire information that we have happily lived without for generations? Structural geologists examine the effects of past stress regimes and recognize that the rocks' responses were functions of their former mechanical properties, the pressure of the fluids within them, and the magnitudes and orientations of the forces that were applied. In the same way, it is recognized that the stresses applied to rocks today can inform us about contemporary deformation processes and allow us to assess the short term geomechanical responses to such activities as mine excavation, the drilling of boreholes,

and the recovery of fluids and solids. The geometry of the "squeeze" (the *in situ* stress) that is applied to a rock mass affects its physical properties and, in turn, it is modified by them.

Rock stress data throw light on the mechanisms that move crustal plates (Zoback *et al.*, 1989), on present day tectonic activity (*e.g.*, Mount and Suppe, 1987), and on how abnormal fluid pressures are generated (Yassir and Bell, 1996). They are needed to assess whether rocks will fail around mine openings (Hoek and Brown, 1980) or in wells (Maury, 1991). They predict the

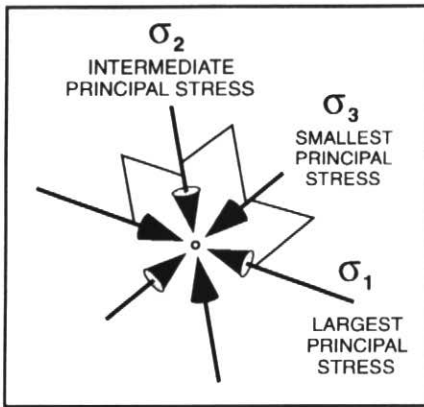

Figure 1 In situ stress at a point in the subsurface can be fully described in terms of the magnitudes and orientations of three orthogonal principal stresses labelled here, in decreasing magnitude as: σ_1 , σ_2 and σ_3 .

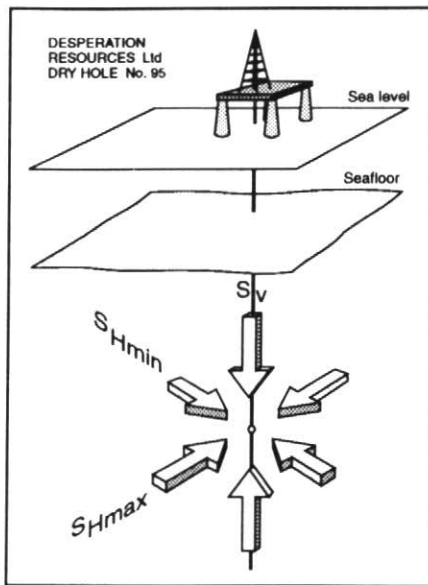

Figure 2 In sedimentary basins, one principal stress, S_v , is assumed to be vertical, whereas the other two, S_{Hmin} and S_{Hmax} , are assumed to be horizontal.

directions in which hydraulic fractures will propagate and what pressures are needed to initiate them (Hubbert and Willis, 1957). They define optimum fluid flow directions in porous rocks (Heffer and Lean, 1991) and play a role in assessing earthquake risk (*e.g.*, Horner *et al.*, 1994). Pragmatically, resource extraction is often more costly and less efficient when stress data are ignored (Bell and McLellan, 1995).

The purpose of this paper and the following one is to review, for non-specialists, the current practices used in the study of *in situ* stress in sedimentary basins. Measurement methods are reviewed in Part I, and practical applications are described and illustrated in

Part II. In both papers emphasis is placed on Canadian case histories.

MEASUREMENT OF IN SITU STRESSES

Stress is a second order tensor and, as such, can be fully described at a point within a rock mass in terms of the magnitudes and orientations of three orthogonal principal stresses, σ_1 , σ_2 and σ_3 (Fig. 1). Much of the Earth's topography is approximately flat to a first order of magnitude, particularly over sedimentary basins, and the rock/atmosphere interface acts as a free surface that orients one principal stress perpendicular to it. Therefore, it has become customary to refer to the three principal

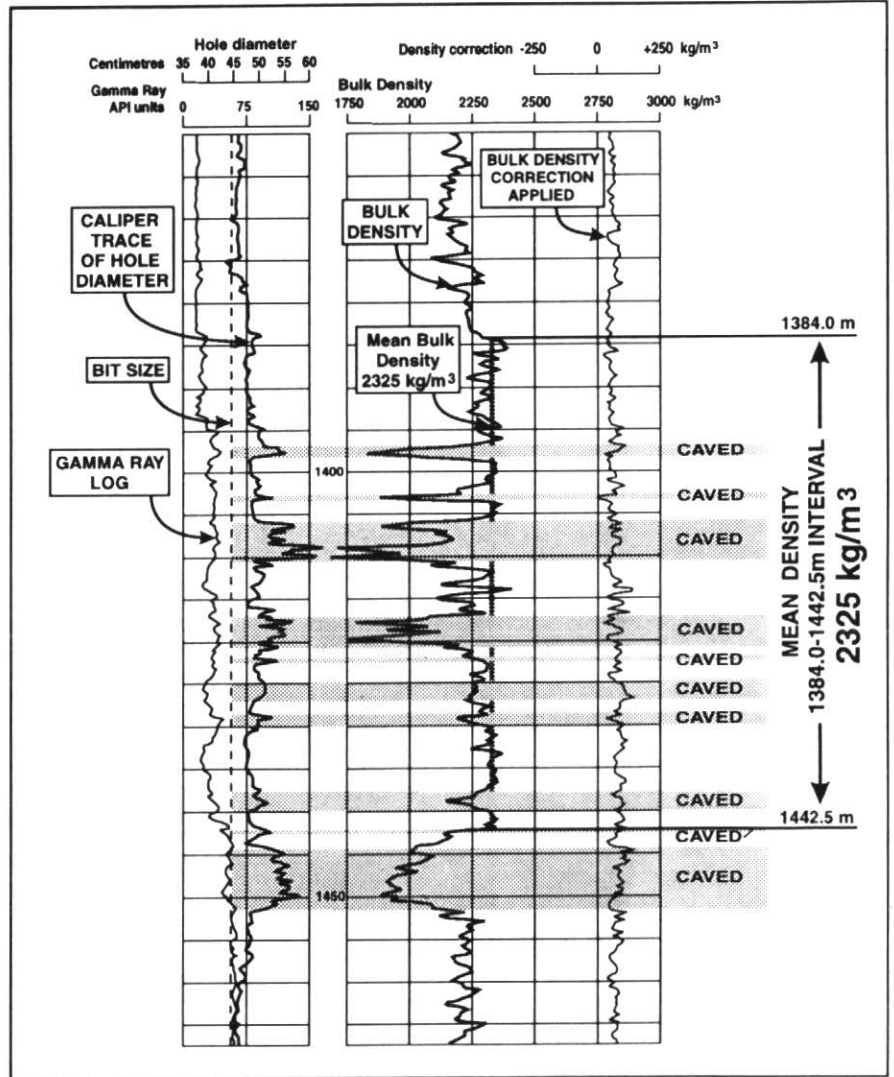

Figure 3 Estimating rock density from a Compensated Neutron-Formation Density log. The vertical line drawn over selected sections of the bulk density curve is the estimated mean value for the 1384.0-1442.5 m interval. Excluded are caved intervals with high caliper extensions for which the values are unrealistically low. In these zones the tool has responded to drilling mud densities rather than solid rock.

stresses as S_v , the vertical stress, and as S_{Hmax} and S_{Hmin} , the larger and smaller horizontal principal stresses, respectively (Fig. 2), with the understanding that this may not be precisely true everywhere. Hence, to define the complete stress tensor at a point in the subsurface within a sedimentary basin, we need to measure four quantities: the magnitudes of S_v , S_{Hmin} and S_{Hmax} , and

the orientation of either S_{Hmin} or S_{Hmax} (Fig. 2). In practice, these quantities are relatively easy to obtain, except for the magnitude of S_{Hmax} .

An overriding concern in large-scale studies involving *in situ* stress is to what extent measurements made by different methods relate to each other. Stress is not compositional, it amounts to directionally dependent force per unit area,

and measuring its magnitude requires that the affected rock body be disturbed to some degree, thereby contaminating the measurements. There is no physical means of sensing stress magnitudes remotely in a rock. Comparing stress orientations is less hazardous, but care should be taken when assessing the compatibility of results obtained by different techniques. That said, stress data compilations for specific basins, using a variety of measurement techniques, have yielded an encouraging consistency at the regional level.

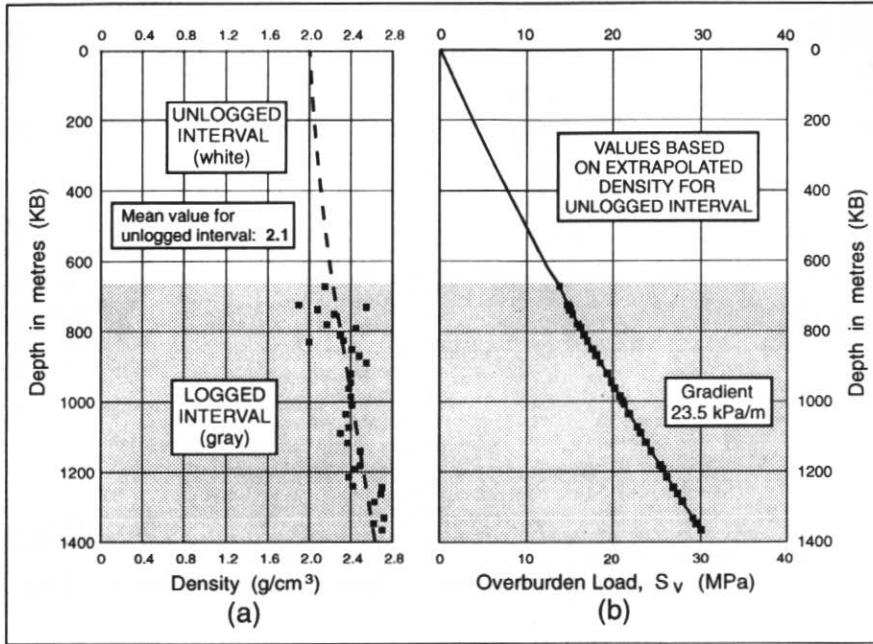

Figure 4 (a) Rock density is plotted against depth over the logged interval and extrapolated to the surface. In this example the unlogged gap has a mean density of 2.1 g cm^{-3} . (b) Plot of overburden load versus depth for estimating S_v . Note that the magnitude of S_v is partially dependent on the extrapolated values of density for the unlogged interval; however, the gradient is not.

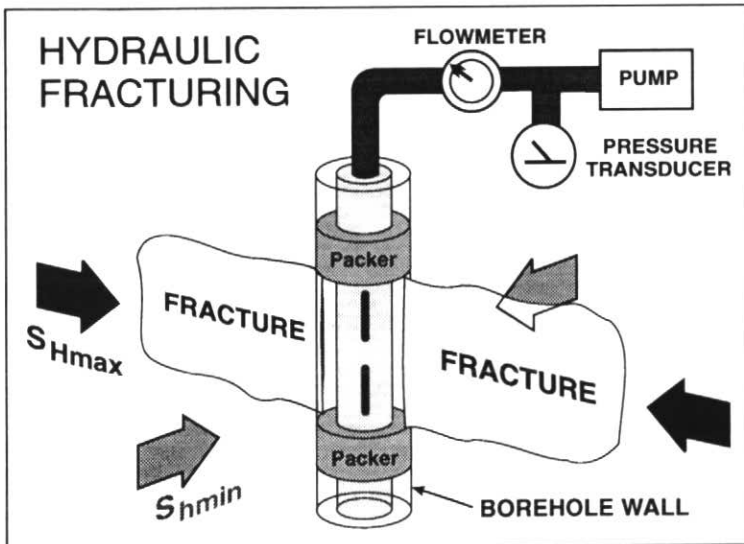

Figure 5 Schematic diagram showing how stress is measured by hydraulic fracturing. The induced fracture will propagate perpendicular to the smallest principal stress, here shown as S_{Hmin} , and close at the magnitude of this principal stress.

STRESS MAGNITUDE MEASUREMENT IN SEDIMENTARY ROCKS

Measuring the Vertical Stress Magnitude

The magnitude of the vertical principal stress, S_v , is the force per unit area applied by the load above the point of measurement. In rocks, this can be inferred from strain relief methods such as overcoring. These techniques are not direct measurement methods since the physical expansions that they measure need to be calibrated against elastic moduli to generate stress magnitudes and orientations. The elastic moduli have to be measured separately with laboratory test equipment. Overcoring measurements are rarely made in sediments, so S_v is usually inferred from the overburden load. This calculation requires good estimates of the densities of rock units above the point of interest. These can be obtained with oil industry density logging tools (Bell, 1990a). The tools are apt to measure drilling mud densities when their pads are not in tight contact with the borehole walls, so caved zones should be excluded and replaced with representative values (Fig. 3). Also, there is usually a gap between the ground surface and the depth at which log records begin. The mean density of this unlogged interval can be estimated by plotting deeper density values against depth and extrapolating to the surface (Fig. 4).

Measuring the Horizontal Stress Magnitudes

Hydraulic Fracturing

The most practical method for measuring the magnitude of the smaller horizontal principal stress, S_{Hmin} , is to cre-

ate a fracture and determine the pressure at which it closes (*i.e.*, just fails to remain open). A hydraulic fracture will split rock apart in a plane perpendicular to the smallest principal stress and the latter's magnitude will be equivalent to the closure pressure of the fracture (Fig 5). If the fracture closes at a pressure less than S_v (as is usually the case), the smaller horizontal stress, S_{Hmin} , is being measured. The advantage of this technique is that it does not require any knowledge of the mechanical properties of the rock. The disadvantage is that fracture closure has to be interpreted from pressure/time records and there is no independent check as to when, or if, it occurred.

Standard hydraulic fracturing involves isolating an interval in a well by enclosing it between inflatable rubber packers, or between drill plugs, that seal the drillpipe against the borehole wall and prevent fluid from flowing up or down the wellbore (Fig.5). Fluid is then pumped into the isolated interval until the pressure builds up to a level at which the rock fractures (Haimson and Fairhurst, 1970). Once a fracture has been initiated, pumping is halted and the pressure decline monitored (Fig. 6). The major change in slope on the decline curve is interpreted as the fracture closure pressure, following the rationale that pressure decline will be rapid initially because, while the fracture is open, fluid can escape through its walls and through those of the borehole whereas, once the fracture closes, the only escape paths left are the borehole walls, which are generally of low permeability, so that the pressure decline becomes much slower. The fractures should be opened and closed several times until a constant closure pressure is achieved (Kry and Gronseth, 1983).

Micro-fracs, in which the volume of injected fracture fluid typically is less than 1 m^3 , are recognized as providing the most accurate and repeatable stress magnitude measurements. Records of the larger mini-frac (injection of $\sim 10\text{ m}^3$ of fluid) and massive fracture treatments (injection of hundreds of m^3 of fluid) undertaken by the oil industry can also yield measures of stress magnitudes (Nolte, 1988a, b), but the interpretations can be complex and will not be further discussed here.

Daneshy *et al.* (1986) described an elegant method for measuring stresses while a well is being drilled. At the cho-

sen depth, the drillpipe is raised above the base of the hole and a packer is inflated to seal it against the borehole wall (Fig. 7). Then the drilling mud pressure is raised until fracturing occurs, after which several pressurizing cycles are run to obtain S_{Hmin} magnitudes. If directional data are required, an oriented core can be recovered. The newly formed fracture will contain drilling mud and its azimuth will correspond to the S_{Hmax} orientation (Fig. 5). This procedure can be repeated at as many depths as necessary.

Leak-off tests

Hydraulic fracture measurements are time-consuming and expensive, so such tests are not performed unless there is a specific reason for requiring the stress data. However, a related practice is much more common, particularly in offshore wells. Formation **leak-off tests** are essentially open-hole micro-fracs that are run as a safety measure to assess how effectively the cement has sealed the casing of a well against the country rock, and to determine the level of fluid pressure that a

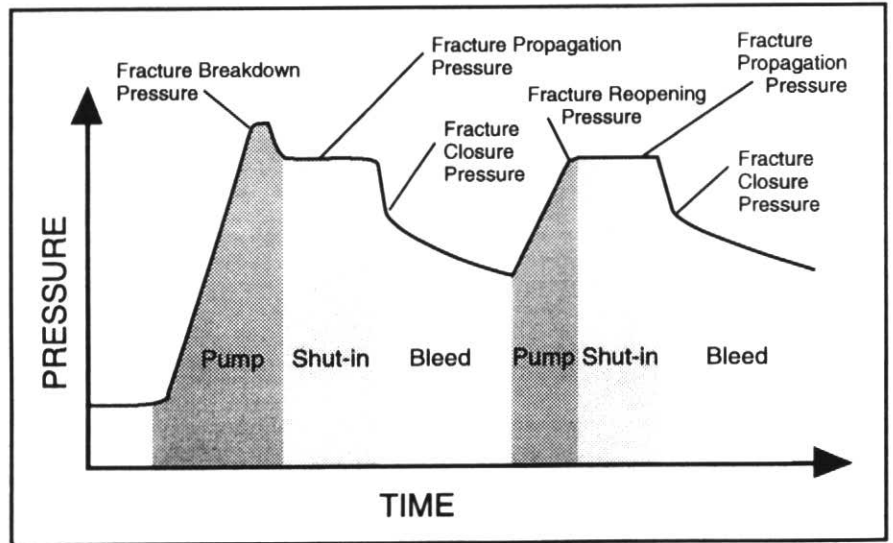

Figure 6 Schematic time/pressure record of a hydraulic fracture stress measurement test involving two pressurization cycles.

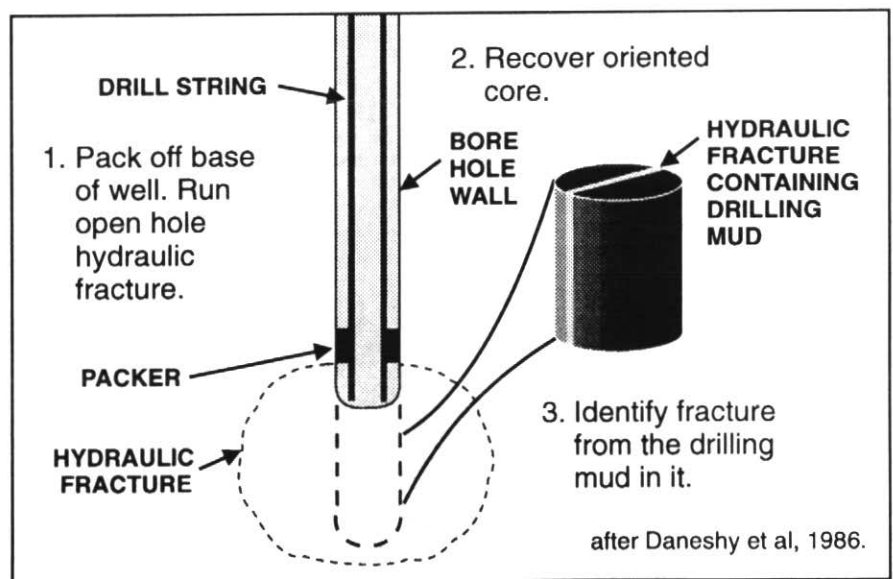

Figure 7 Packer and drillpipe arrangement for inducing hydraulic fractures at the base of a well. If an oriented core is subsequently recovered, the newly created fracture can be identified and its azimuth used to diagnose the S_{Hmax} axis. Alternatively, the induced fracture's orientation can be determined later from borehole imagery logs.

well can sustain before its walls fracture. Leak-off tests are performed as follows (Dickey, 1986). After tubular casing has been lowered into a well and cemented against the surrounding rock, the basal cement is drilled out and the well is

advanced several metres into fresh rock. Drilling is then stopped and the mud pressure raised by pumping drilling fluid into the wellbore at a constant rate until a fracture is initiated in the wall of the borehole (Fig.8). Fracture initiation causes the rate of pressure increase to decline, because the fluid is now "leaking off". The highest pressure reached before this decline occurs is defined as the leak-off pressure (Fig. 9a). If post-pumping pressures are monitored, the smallest principal stress corresponds to the pressure at which rapid pressure decline ceases, since this corresponds to the closing of the fracture (Fig. 9a).

Figure 9a shows that leak-off (fracture initiation) typically occurs at a higher pressure than that at which the fracture will close, so that leak-off pressures *per se* will usually overestimate stress magnitudes; closure pressures will be closer to true values and, if several tests are run over the same interval, greater precision can be expected. In fact, a leak-off pressure from a single test will, at best, yield a formation breakdown pressure (compare Fig. 9a with Fig. 6). Second and subsequent tests are likely to reopen the newly created fracture at lower pressures because the tensile strength of the rock has been overcome already. Breckels and Van Eekelen (1981) compared leak-off test pressures with fracture closure pressures obtained from hydraulic fracturing in wells in the Gulf Coast and Brunei and found that, although individual leak-off pressures were often greater than equivalent hydraulic fracture closure pressures, there was a correspondence between the lowest values of both data sets. On depth/pressure plots, the "lower bound" curves enclosing the leak-off pressures defined the mean stress magnitude gradient as determined by hydraulic fracturing. Breckels and Van Eekelen's results show that formation breakdown pressures often were only marginally higher than fracture closure pressures, implying that rock tensile strength was negligible in the study areas. Similar results have been obtained elsewhere, including western Canada.

In recent years, leak-off tests have been receiving more prominence for stress measurements, particularly in active exploration arenas like the North Sea. It is recognized that standardization of procedures is desirable and that repeatable results are best obtained when slow pump rates of the order of 0.25 barrels·min⁻¹ are used (R.K. Bratli, pers. comm., 1994). Extended leak-off tests (Kunze and Steiger, 1992; Hillis and Williams, 1993), which involve opening and closing the induced fracture several times, are also being introduced. As Figure 9b illustrates, their results mimic those of micro-frac tests, yielding excellent measurements of stress magnitudes.

An extended leak-off test monitors

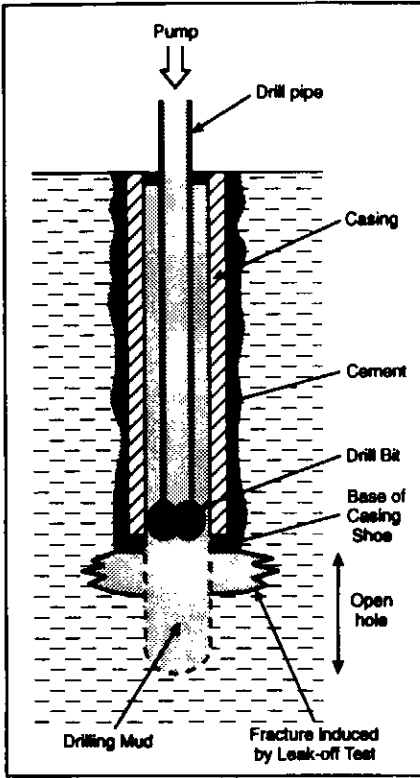

Figure 8 Schematic representation of a leak-off test.

Figure 9a shows that leak-off (fracture initiation) typically occurs at a higher pressure than that at which the fracture will close, so that leak-off pressures *per se* will usually overestimate stress magnitudes; closure pressures will be closer to true values and, if several tests are run over the same interval, greater precision can be expected. In fact, a leak-off pressure from a single test will, at best, yield a formation breakdown pressure (compare Fig. 9a with Fig. 6). Second and subsequent tests are likely to reopen the newly created fracture at lower pressures because the tensile strength of the rock has been overcome already. Breckels and Van Eekelen (1981) compared leak-off test pressures with fracture closure pressures obtained from hydraulic fracturing in wells in the Gulf Coast and Brunei and

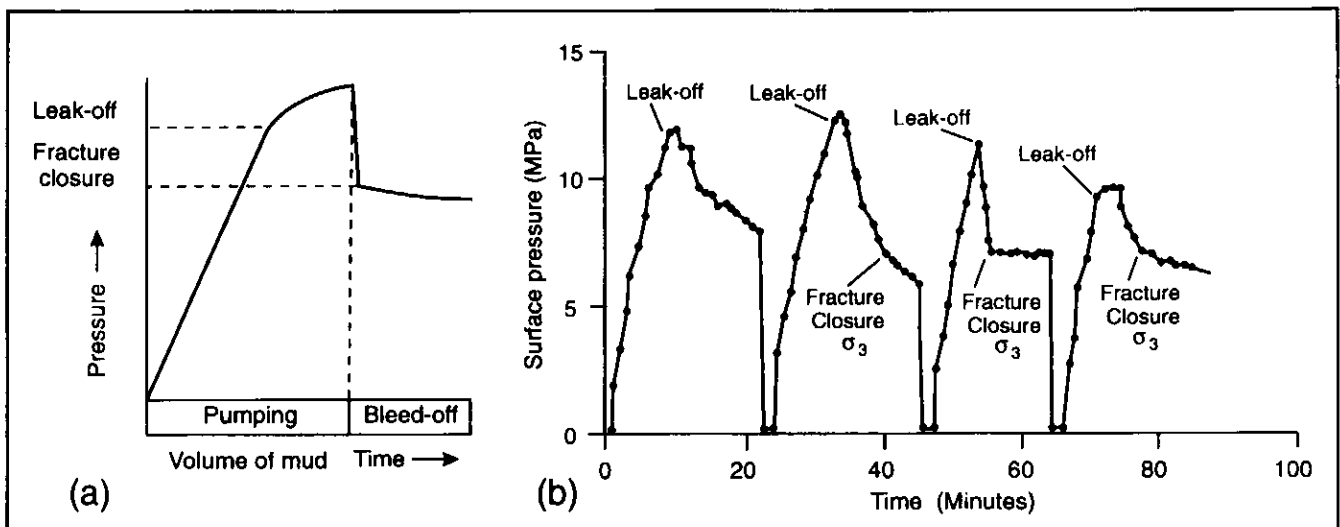

Figure 9 (a) Idealized pressure history of a leak-off test. Note that leak-off is reached at the point where the pressure increase ceases to be linear. This is when a fracture is initiated. If the subsequent pressure decline is monitored, as shown here, the pressure at which rapid decline ceases can be interpreted as the closure pressure of the fracture, and equated with the smallest principal stress. Both leak-off and closure pressures represent the sum of the weight of the mud column, plus the rig floor pump pressures. (b) Results of an extended leak-off test (redrawn from Kunze and Steiger, 1991). The second, third and fourth pressurization cycles give repeatable values of the fracture closure pressure (= σ_3).

the pressure decline of successive closings of the same fracture, so it is preferable to a sequence of leak-off tests. On the Scotian Shelf, successive tests were run as the Venture B-43 well was deepened and, each time, the length of open hole between the base of the casing and the bottom of the well was different. Unless borehole image records are gathered after each test, there is no way of being certain that every one of such a series of tests opened and closed the same fracture. However, the major limitation to conventional leak-off tests, extended or otherwise, is that they only provide stress magnitude information at specific depths, namely at the base of casing strings. For most wells, this means that there will be between two and five readings; not neces-

sarily at the depths of greatest interest. The most straightforward solution to this dilemma is to make micro-frac stress measurements as a well is being abandoned, using a combination of cement plugs and packers to isolate the zones of interest. Saga Oil have done this in several North Sea wells (R.K. Bratli, pers. comm., 1994), but the practice is not widespread.

Estimating and Measuring S_{Hmax}

None of these fracturing techniques measures S_{Hmax} . It can be calculated using the relationship derived from Hubbert and Willis (1957) which states that:

$$S_{Hmax} = 3S_{Hmin} - P_b - P_o - T$$

where P_b is the breakdown pressure, P_o is the pore pressure, and T is the tensile strength. This equation applies to pres-

sure data gathered during the first opening and closing of a hydraulic fracture (Fig. 6). If the fracture is being re-opened, and there is no residual tensile strength, the relationship simplifies to:

$$S_{Hmax} = 3S_{Hmin} - P_r - P_o$$

where P_r is the reopening pressure (Fig. 6). These equations also can be applied to the results of leak-off tests (Bell, 1990b), and are particularly relevant for extended leak-off tests. The relationships assume that the rocks concerned are completely impermeable, are mechanically isotropic, and that their elastic behaviour is linear, so the best results are likely to be obtained from shales, mudstones and carbonates. For hydrostatically pressured rocks and the range of normally encountered stress magnitudes, the equations limit the

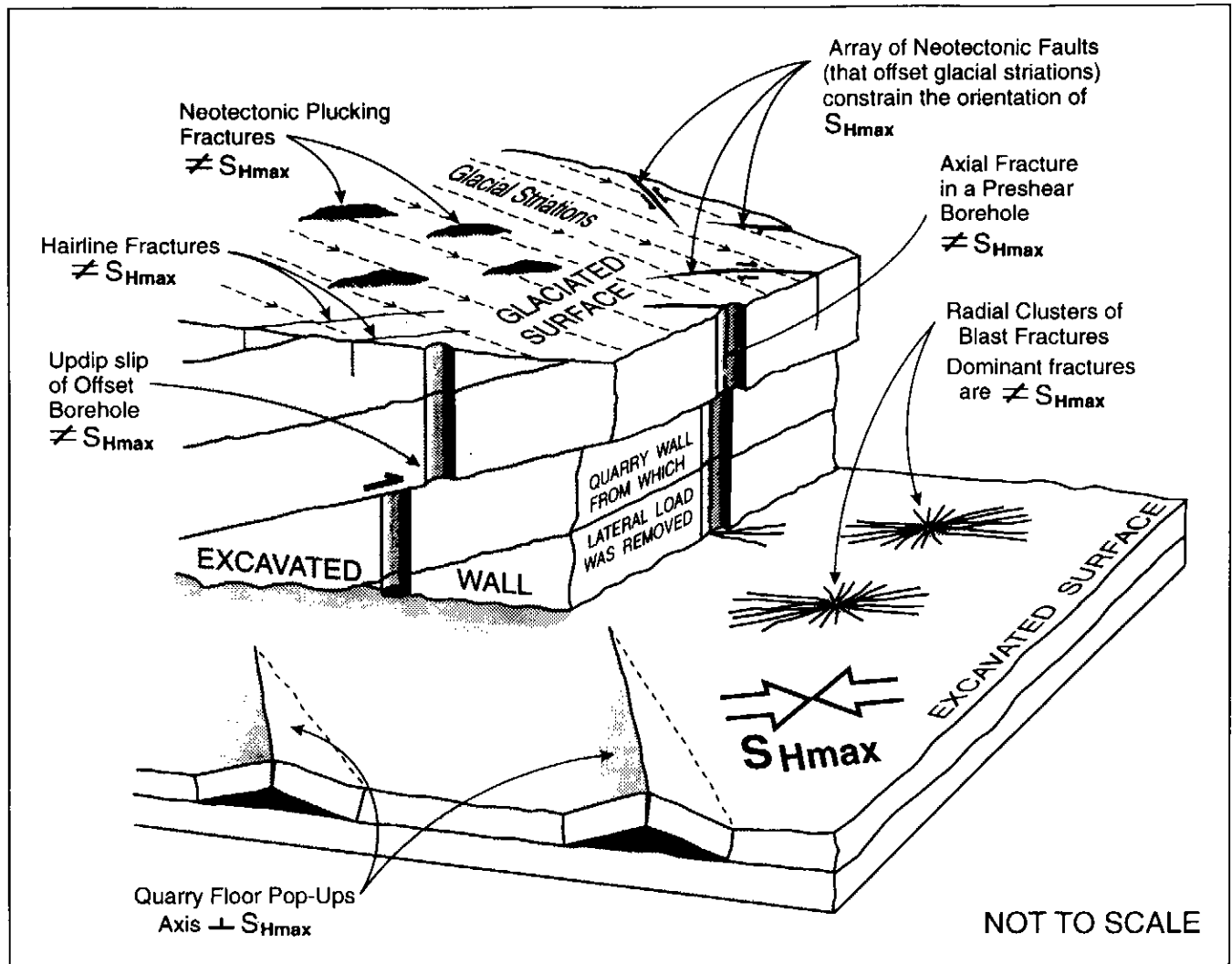

Figure 10 Schematic composite figure illustrating near surface geological features that are diagnostic of contemporary stress orientations. The dashed lines on the upper rock surface represent glacial striations caused by ice movement in the direction of the arrows. The various features and limitations to their use are described in the text. Note that all the diagnostic features are aligned parallel with S_{Hmax} , except for the pop-up anticlines where the long axis is perpendicular to S_{Hmax} , and the fault arrays.

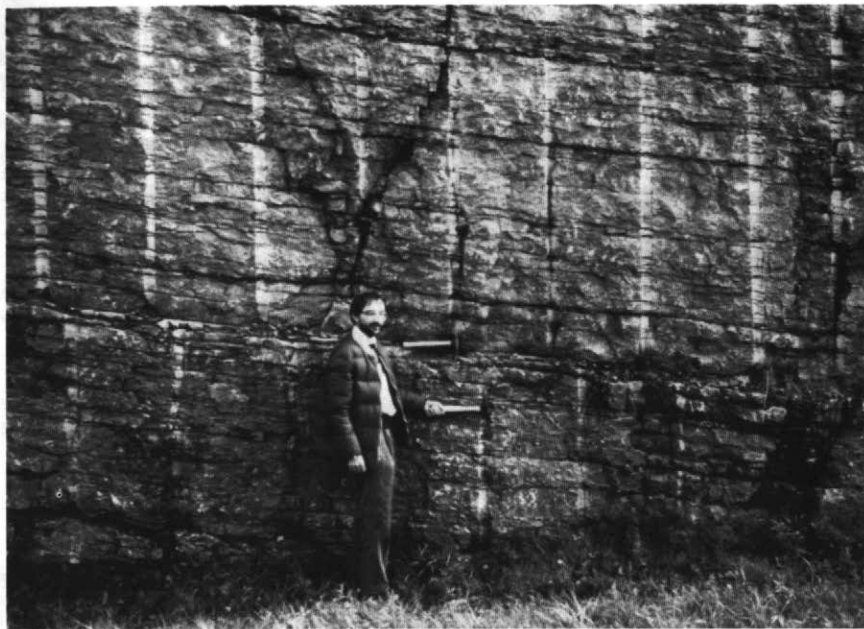

Figure 11 Offset boreholes exposed along the St. Laurent exit ramp off Autoroute 50 in Hull, Quebec. The average direction of offset is 070° , which coincides well with regional S_{Hmax} orientations determined from hydraulic fractures, breakouts and earthquake focal mechanisms. Details are given by Wallach et al. (1995).

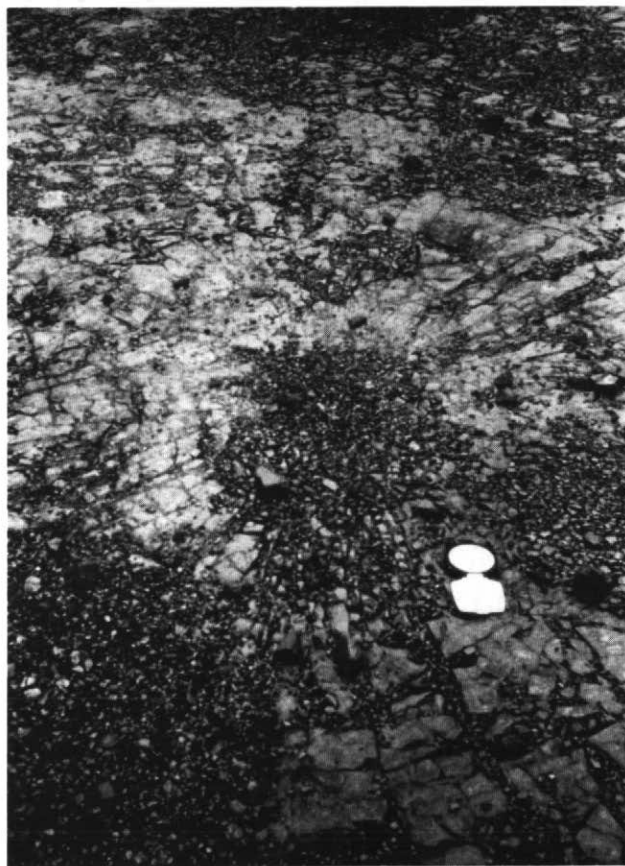

Figure 12 Fractures radiating out from a small explosion crater on the floor of McFarlane Quarry, near Ottawa, Ontario. The major population of fractures is aligned parallel to the open Brunton compass and clusters close to the azimuth of S_{Hmax} as defined by other criteria in the region.

ratio of $S_{Hmax}:S_{Hmin}$ to less than 1.7:1.0. This is reasonable according to elastic theory, but conflicting results exist. Higher $S_{Hmax}:S_{Hmin}$ ratios, in excess of 2.0:1.0, have been inferred from over-coring measurements made in crystalline rocks of the Canadian Shield in southern Ontario and Quebec (Adams, 1995, data compilation), as well as elsewhere (e.g., South Africa, McGarr and Gay, 1978).

Cornet and Valette (1984) developed an ingenious method of measuring S_{Hmax} and S_{Hmin} simultaneously by means of **hydraulic tests on pre-existing fractures** involving opening and closing two or more natural fractures that cut a wellbore at different angles. Because of these requirements, their approach has not been repeated often (Cornet, 1993). Another special circumstances method is that of Aadnoy (1990), who inverted leak-off test pressures from a group of differently oriented inclined wells. This is a potent technique for oil fields that are being developed by directional drilling. However, it assumes that one is dealing with a single stressed rockmass. If the data come from several fault blocks with different stress signatures, the results might be meaningless. As well, various approaches have been devised to constrain S_{Hmax} magnitudes within geomechanically allowable limits (Moos and Zoback, 1990; Tan et al., 1993; Peska and Zoback, 1995).

Borehole Slotting

Borehole slotting is a technique that might be used to measure both S_{Hmin} and S_{Hmax} in deep wells although, to date, the deepest published measurements are at 17 m (Bock, 1993). The technique involves cutting a slot in a borehole wall with a circular saw while monitoring the tangential strain in the vicinity of the slot. Data from three slots 120° apart, plus measurements of the elastic constants of the rock (Young's Modulus, E , and Poisson's Ratio, ν), yield 2D stress magnitudes and orientations, so it would be worthwhile to attempt to develop hardware for deep vertical wells.

Core-based Techniques

In theory, core-based techniques can be used to measure the magnitude of the larger horizontal principal stress, S_{Hmax} , in the subsurface (Warpinski et al., 1993). However, the two techniques

which have been used to do this, **anelastic strain recovery** (see below) and **differential strain curve analysis**, suffer from uncertainty regarding the fundamental assumptions behind their interpretations and from operational problems that plague the measurements. As is discussed below, core-based methods are more effective in supplying stress orientations than magnitudes.

STRESS ORIENTATION MEASUREMENT IN SEDIMENTARY ROCKS

Stress orientation measurements concentrate largely on determining the axes of S_{Hmin} or S_{Hmax} , since the other principal stress is assumed to be vertical.

Surface Indicators

Near-surface features can provide reliable guides to stress directions at depth (Fig. 10). The features have to be demonstrably contemporary or recent, and they should be located in sites that are free from topographic or rock fabric effects that might distort regional stress orientations. Thus, phenomena diagnostic of stress orientations can be identified in areas of subdued topography among structurally massive rocks in settings where the features can be dated. Furthermore, the phenomena are best developed in regions where strongly anisotropic horizontal stresses are acting and where the near-surface horizontal stress magnitudes are significant.

Among the features used are small stress relief anticlines, manifested as "pop ups" on highly stressed quarry floors, or on other surfaces of flat-bedded fissile rock from which a constraining load has recently been removed (Fig. 10). The mean orientation of their anticlinal axes will be approximately perpendicular to S_{Hmax} (Adams, 1982; Wallach *et al.*, 1995), provided there is no geomechanical interference from nearby quarry walls, topography or pre-existing rock fabric. Stress relief may be accomplished also by updip slip on bedding planes within excavated rock bodies. This is not usually apparent, unless a marker such as a preshear borehole trace is visibly offset (Figs 10, 11). In specific situations, the displacement vector can define the local axis of S_{Hmax} ; (Bell, 1985; Wallach *et al.*, 1995), but care has to be taken to ensure that the observed updip slip is not part of a

surficial gravity-controlled rotational slump (Meinardus *et al.*, 1993).

Hancock and Engelder (1989) noted that many regional non-mineralized fracture sets with no offsets were parallel to S_{Hmax} and suggested that they were diagnostic of contemporary stress orientations. Subsequently, Lorenz *et al.* (1991) showed that regional fractures could indeed open parallel to S_{Hmax} , but that this process probably occurs at some depth. In other words, they would be diagnostic of today's orientations only if the stress configuration had not altered since the rocks were buried. Nevertheless, **brittle fractures parallel to S_{Hmax}** can form at the sur-

face. Hoek and Brown (1980) published a diagram showing an explosion site with fractures radiating away from it, and indicated that the dominant fracture set defined S_{Hmax} . Similar radial clusters of blast fractures have been observed on the floor of the McFarlane quarry near Ottawa (Fig. 12). They formed at the base of vertical drill holes in which charges were placed to break down the limestones (Figs. 10, 12). **Axial fractures**, believed to be explosion induced, that extend into the country rock from preshear borehole faces in roadcuts (Fig. 10) also have been interpreted as propagating parallel to S_{Hmax} (Bell and Eisbacher, 1996).

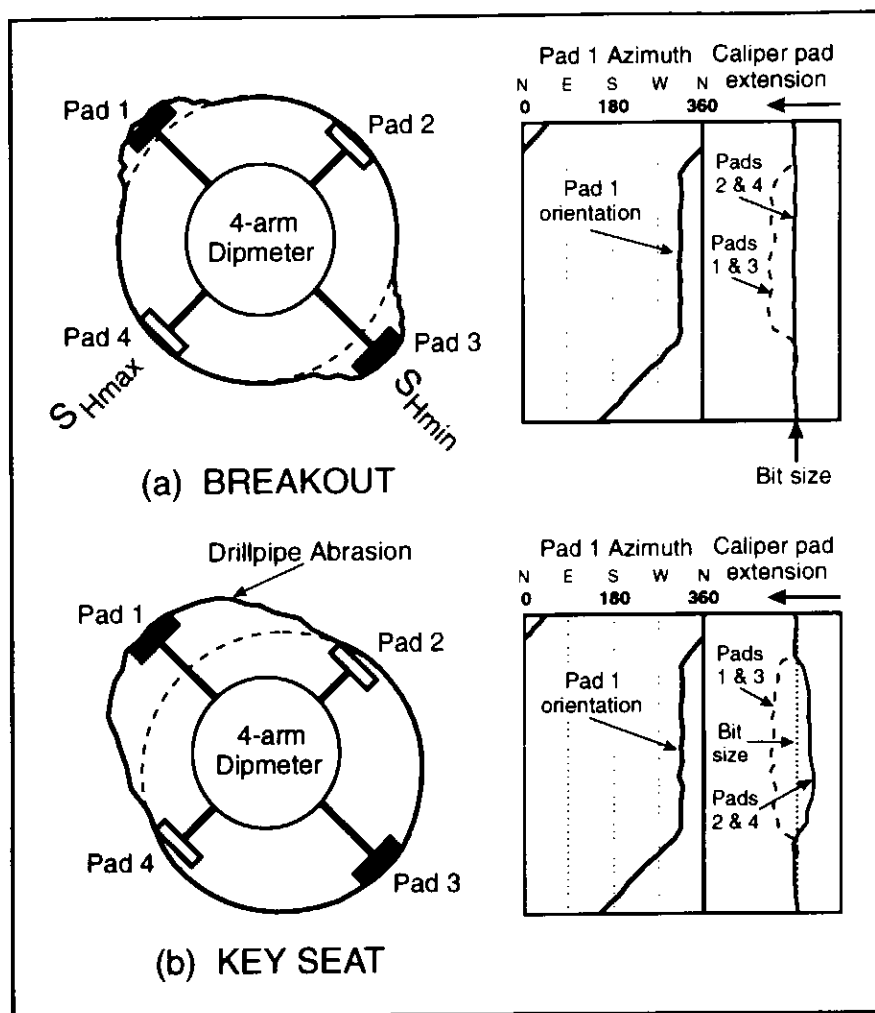

Figure 13 (a) Left: Relationship between borehole ellipticity and principal stress orientations in a vertical well. (a) Right: Typical four-arm caliper signature of a breakout. (b) Left: Cross section of a key seat zone, in which one side of the borehole wall has collapsed so that the well cross section is pear shaped. This can occur when the drillpipe grinds preferentially against the top side of an inclined well. (b) Right: Typical key seat signature where the four-arm caliper records differential extension of the calipers, but where one pair is extended less than the drill bit diameter. If the azimuth of such an elongation is similar to the well's horizontal deviation direction, key seating is likely. Breakouts are diagnostic of principal stress orientations; key seats are not.

The widespread melting back of glaciers since the 1850s has reduced the vertical load on underlying rocks. This has released lateral stresses and given rise to **hairline extensional fractures** parallel to S_{Hmax} (Fig. 10), as well as **neotectonic plucking fractures** (Fig. 10), which are excavated steps, similar to a roche moutonnée, that are aligned obliquely to glacial striations (Bell and Eisbacher, 1995, 1996). Plucking fractures are planes of surficial tensile failure that result from moving ice shearing and plucking at rocks which have been weakened by stress relief. Provided the rocks concerned are massive and have no internal fabric (joints, etc.) that could control their geomechanical behaviour, the plucking fractures will reflect principal *in situ* stress orientations and their mean azimuth should correspond with S_{Hmax} . Small-scale stress relief **fault arrays** (Fig. 10), such as those involving microfaults that offset glacial striations (Bell and Eisbacher, 1996), can be used also to constrain principal stress orientations.

These types of geological indicators have proved useful on the St. Lawrence Platform in Ontario and Quebec, where brittle well-indurated flat-lying rocks are commonly present at the surface and near-surface horizontal stress magnitudes and horizontal stress anisotropy are anomalously high (Adams and Bell, 1991). They have limited application in

the Western Canadian Sedimentary Basin, where the outcropping rocks are softer and subject to lower stress magnitudes (Bell *et al.*, 1994), but they have been recognized in the mountains of the Western Cordillera (Bell and Eisbacher, 1995, 1996). The only surficial geological phenomena that can be used to infer stress orientations in offshore basins are recent faults that offset the sea floor. These can be identified on shallow seismic "sparker" profiles and, usually, are not numerous (*e.g.*, Fader, 1991).

At a larger scale, the attitudes of mappable active faults will give broad hints of the regional stress orientations in a sedimentary basin. For example, the coast-parallel traces of recent listric normal faults in the Gulf Coast imply that

S_{Hmin} is oriented normal to their traces. Similarly, the traces of active strike slip faults and active thrust faults will provide constraints on the orientation of S_{Hmax} in their vicinity.

Subsurface Indicators of Stress Orientations

Breakouts

At drill depths in sedimentary basins, the best indicators of horizontal stress orientations are wellbore breakouts (Fig. 13a, 14a). Breakouts are intervals in wells where caving has occurred on the opposite sides of the borehole so that its cross section becomes semi-elliptical or "ovalized". The long axis of a

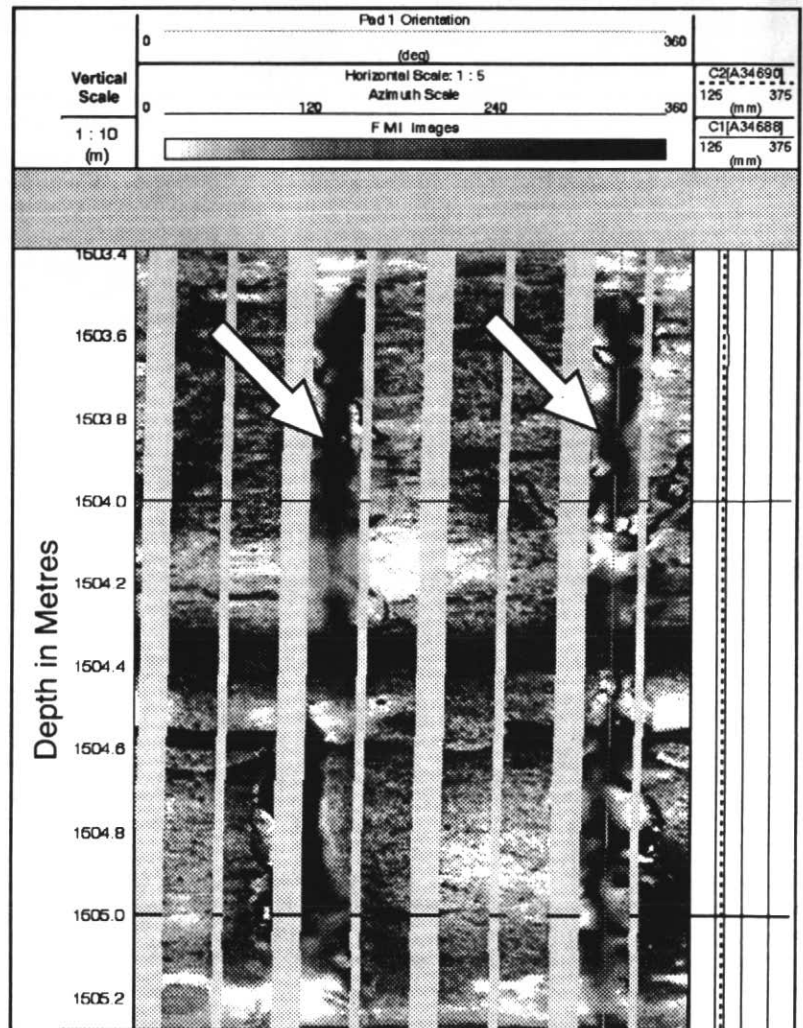
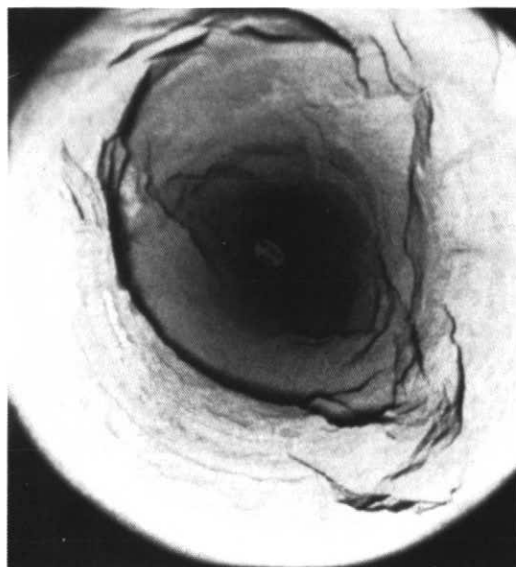

Figure 14 (a) Left: Downhole view of a breakout zone, where the wellbore has become ovalized because of stress-induced caving of the hole walls, in tuff at the Nevada Test Site, USA (photograph provided by J.E. Springer). (b) Right: An unrolled Formation Micro-Imager log. The arrows denote vertical unfocused images at azimuths of 130° and 310°. Beside the unfocused zones are discontinuous arcuate fractures. This FMI log portrays breakout incipient spalling (arcuate fractures) and well-developed breakout caving (unfocused zones, where the pads cannot press up against the borehole wall). Such images emphasize the bipolar symmetry of breakouts.

breakout is aligned with the smaller principal stress (S_{Hmin} , in the case of a vertical well). "Breakout" is thus a genetic term, implying the existence and action of anisotropic stress. Without supporting data it is impossible to say categorically whether a specific ovalized zone should be used to diagnose stress orientations. There are, however, well-defined criteria for distinguishing zones that should be rejected. In particular, possible keyseats should be avoided. These are zones where the borehole has been elongated laterally in one direction only so that the borehole cross section resembles a keyhole (Fig. 13b). If the data sources are borehole images, there is usually no difficulty in identifying genuine breakouts. They are distinctive bipolar features (Fig. 14b). However, much borehole morphology information still comes from four-arm dipmeters, or similar tools equipped with two or more extendable pairs of oriented pads, which can only feel the gross inside shape of the well and will not necessarily indicate unambiguously whether the two opposite sides of the

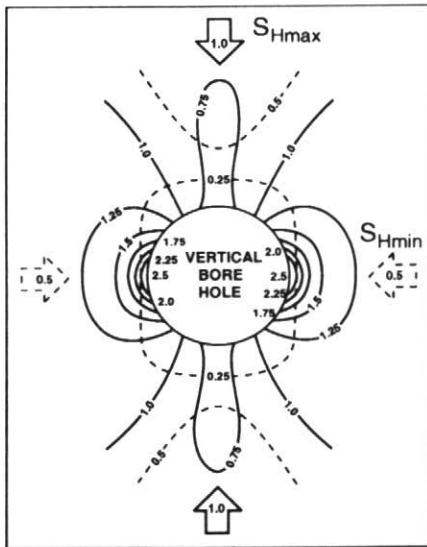

Figure 15 Stress magnitude variation around an anisotropically stressed borehole, where the far field stress ratio is 1.0:0.5, according to Hoek and Brown (1980). Note how the contrast in the two principal stress magnitudes varies around the hole. Shear fractures are most likely to occur where this is greatest (where the strength of the rock is exceeded) within the lunate arcs at 9 o'clock and 3 o'clock and these zones will be most likely to cave to form breakouts. In this linear elastic simulation, the ratio between the two principal stresses approaches 10:1 (2.5:0.25) in these areas.

hole have caved. Hence, it is prudent to reject ovalized zones with long axes that closely parallel the horizontal deviation direction of the well, and it is wise to avoid making measurements in sections where the vertical inclination exceeds 5° (Mastin, 1988). Judgement should be used to determine the cut-off criteria, which will depend on the anisotropy of the stress regime and the hardness of the rocks (Bell *et al.*, 1993). If both are high, stress-induced elliptical caving will overwhelm any borehole wall collapse induced by drillpipe wear or other effects.

Why should an elliptically spalled zone in a vertical, or near vertical, well be diagnostic of anisotropic stress and be oriented so that its long axis is aligned parallel with S_{Hmin} ? The solution to this problem is nearly one hundred years old and was first published in a German engineering journal (Kirsch, 1898). Kirsch's elegant lithographs show how stress magnitudes vary around a circular opening that is subject to uniaxial stress, according to linear elastic theory. The breakout situation is actually better simulated by biaxially stressing a circular opening, as shown

in Figure 15. On the left and right sides of the figured borehole wall, the larger principal stress (1.0) is amplified two and a half times, whereas the smaller principal stress (0.5) is reduced by half. This results in a stress ratio of the order of 10.0, which is felt within two lunate (ear-shaped) regions abutting facing walls of the hole. Such a level of stress anisotropy will promote shear failure in rocks with low cohesive strengths and thereby generate a population of fracture planes which will coalesce and cause cavings that will spall off on opposite sides of the hole so as to elongate it elliptically and produce a breakout. Zoback *et al.* (1985) simulated the process using Mohr-Coulomb fracture criteria and, although there has been discussion that not all breakouts originate in this manner (*e.g.*, Maury, 1991), the correspondence is close enough to imply that linear elastic failure fits most situations.

The analysis behind Figure 15 implies that breakouts will be more common and more deeply excavated in rocks that are subject to significant stress anisotropy, and that their occurrence and abundance will be inversely related to effective rock strength. These predic-

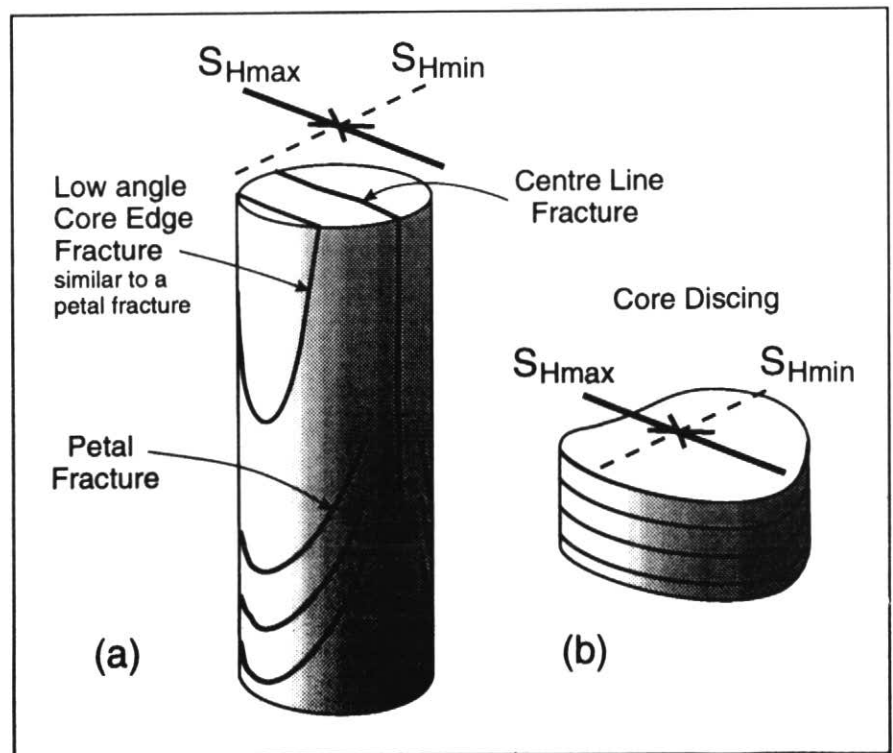

Figure 16 (a) Classical centre line fracturing, petal fracturing and core edge fractures as observed in cores cut in vertical wells. In each case the fracture strike parallels S_{Hmax} . (b) Core discing in a core cut in a vertical well. Where saddles and peaks are developed, S_{Hmax} will be aligned along the axis of the saddles.

tions are quantitatively supported by modelling (e.g., Haimson and Song, 1993) and are confirmed by field experience (Bell *et al.*, 1993). Breakouts are extremely common in wells, and enough caliper logs have been run for breakout analysis to have become the most widely applied method for mapping stress orientations in sedimentary basins. Because failure process involves the borehole wall sensing stress anisotropy that exists around it, breakouts appear to give more accurate measurements than most other methods.

How can we be sure that we are mapping present day stresses with breakouts; is it possible that we are sensing paleostresses? The mechanism of breakout development argues against the action of residual stresses, unless the wellbore ovalization is controlled by a rock fabric that is demonstrably related to a previous stress regime. This

situation has been encountered occasionally in steeply dipping gneisses, but never in sedimentary beds. What is particularly striking in the Western Canadian Basin (Bell *et al.*, 1994) and elsewhere (Adams, 1995) is how horizontal stress orientations diagnosed by breakouts coincide with those documented by induced fracturing and other measurement methods. In the Appalachian Basin, breakouts and hydraulic fractures unambiguously indicate that S_{Hmax} is oriented NNE-SSW today (Plumb and Cox, 1987), yet there is abundant structural evidence that S_{Hmax} was oriented NNE-SSW in late Paleozoic time (Engelder and Geiser, 1980). No stress measuring technique has recovered any Paleozoic orientations from that region. Thus, it would appear that sediments generally do not retain an orientational signature paleostresses.

Core Features

Cores that have been raised from significant depths undergo stress relief. Some cores from semi-vertical wells split apart along commonly oriented planes that are sub-parallel to their length (Fig. 16a). This type of fracturing manifests itself as classical **centre line fracturing** (Plumb and Cox, 1987), as **petal fracturing** (Kulander *et al.*, 1990), or as fracturing related to a weakness along the edge of a core sample (Lorenz *et al.*, 1990). In each case, the strike of the fracture corresponds to S_{Hmax} (Fig. 16a). These **coring-induced fractures** are excellent for diagnosing stress orientations, and are best observed as soon as the core has been recovered and before it is slabbed. To infer stress directions, the core must be oriented, either during coring, or later, with borehole images or paleomagnetic techniques (Fuller, 1969; Hamilton *et al.*, 1995). Diagnostic fractures should not be mineralized nor possess features such as slickensides that would imply that they existed prior to coring.

Occasionally, **core discing** will provide stress orientations, provided the core can be oriented. This self-explanatory term describes strain relief cracks that form perpendicular to the core axis, a self-destructive process that infuriates sedimentologists! Core discing is diagnostic of high stresses normal to the core axis; in a given rock type, the higher the stresses the thinner the discs (Obert and Stephenson, 1965). If the discs are saddle-shaped (Fig. 16b), the axes of the saddles will be parallel to S_{Hmax} (Paillet and Kim, 1987; Maury *et al.*, 1988).

Stress Relief Methods

Stress relief is not always accompanied by visible splitting; the core can simply expand, although this usually involves the opening of micro-cracks. Core expansion, or **anelastic strain recovery**, can be recorded by spring-loaded gauges placed around unfractured homogeneous pieces of core soon after they have been recovered. There are considerable operational problems involved in making the measurements (Warpinski *et al.*, 1993) but, if these can be overcome, the orientations of the principal stresses can be determined from the orientations of the principal recovered strains. The strain recovery measurements need to be made within 36 hours of coring, because this is when

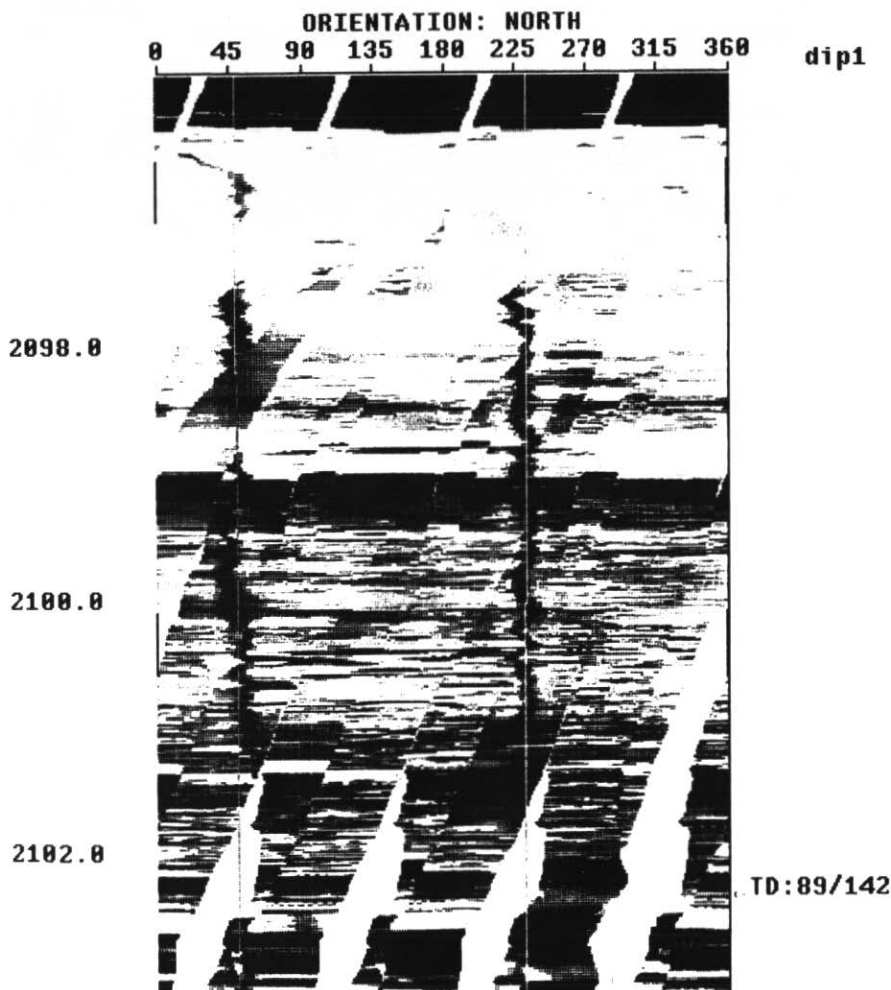

Figure 17 An unrolled Formation Microscanner image of a hydraulic fracture propagated into Cretaceous Cardium sandstones in the Ferrier field, Alberta (from Parker and Heffernan, 1992). The fracture is shown by the semi-vertical jagged black signatures at approximate azimuths of $N45^{\circ}E$ and $S225^{\circ}W$.

most of the expansion occurs. ASR-derived stress orientations are usually within 20° of breakout inferences.

The relative strain relaxation that a core underwent shortly after it was raised to the surface can be inferred years later by compressing the same core hydrostatically and measuring the relative contraction that occurs. The presumption is that the core sample will compress in direct relation to the degree it expanded, since the latter process involved the opening of a network of microcracks which the former treatment closes. Gauges attached to the sample to measure the strain provide the basic information for determining stress orientations. As before, the core must be oriented.

Rock Anisotropy

The presumption that the greatest volume of microcracks will be those which open parallel to the largest *in situ* stress when a core is raised to the surface forms the rationale for measuring **acoustic velocity anisotropy** to obtain stress orientations. With this technique, an oriented core sample is rotated between two P wave transducers (one acting as a source and the other as the receiver), and the velocity is measured at different angles until a full 180° circuit has been completed. The direction of the least stress corresponds to the orientation where the slowest velocity was measured. There are problems with using a rock's fabric to diagnose a principal stress orientation because the one is not necessarily related to the other. Some rocks possess a pre-existing fabric that overwhelms the strain relief signature, and this can lead to confusing results. The same limitation applies to **shear wave splitting**, which much theoretical and experimental evidence (Crampin, 1978; Rathore *et al.*, 1993) suggests is caused frequently by aligned microfractures. It appears to be a powerful method for mapping reservoir fabric anisotropy, but not necessarily for determining stress orientations, since the fractures need not reflect today's stress regime.

Hydraulic Fractures

Induced extensional fractures propagate along the plane of easiest failure which will be aligned perpendicular to the smallest principal stress so, if their geometry can be determined, they are excellent indicators of stress orienta-

tions. The propagation directions of **hydraulic fractures** (Fig. 5) have often been determined by using oriented impression packers to record the fracture trace on the borehole wall. Borehole images can supply the same information and, ideally, the recording tools should be run before and after fracturing to ensure that the identified image truly represents a newly-created hydraulic fracture (Fig. 17). If a hydraulic fracture's orientation cannot be directly recorded there are various ways of sensing it remotely (Fig. 18). For large induced fractures at several kilometres depth, the propagation direction can be determined by measuring ground surface deflections with sensitive tiltmeters (Davis, 1983). A vertical fracture will generate a tiny linear uplift with a median valley that mimics the fracture's configuration in the subsurface (Pollard and Holzhausen, 1979). Another approach has been to map the microseismic events, or **acoustic emissions**, which accompany the initiation and advance

of a hydraulic fracture. Talebi *et al.* (1991) installed geophones in surrounding wells and recorded acoustic emissions that gave a hydraulic fracture azimuth of N30°E to N40°E for a well near Kind-

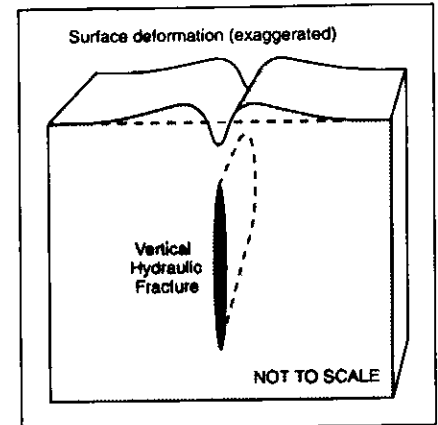

Figure 18 Schematic portrayal of ground deformation associated with hydraulic fracturing at depth, looking down the length of the fracture (derived from Pollard and Holzhausen, 1979).

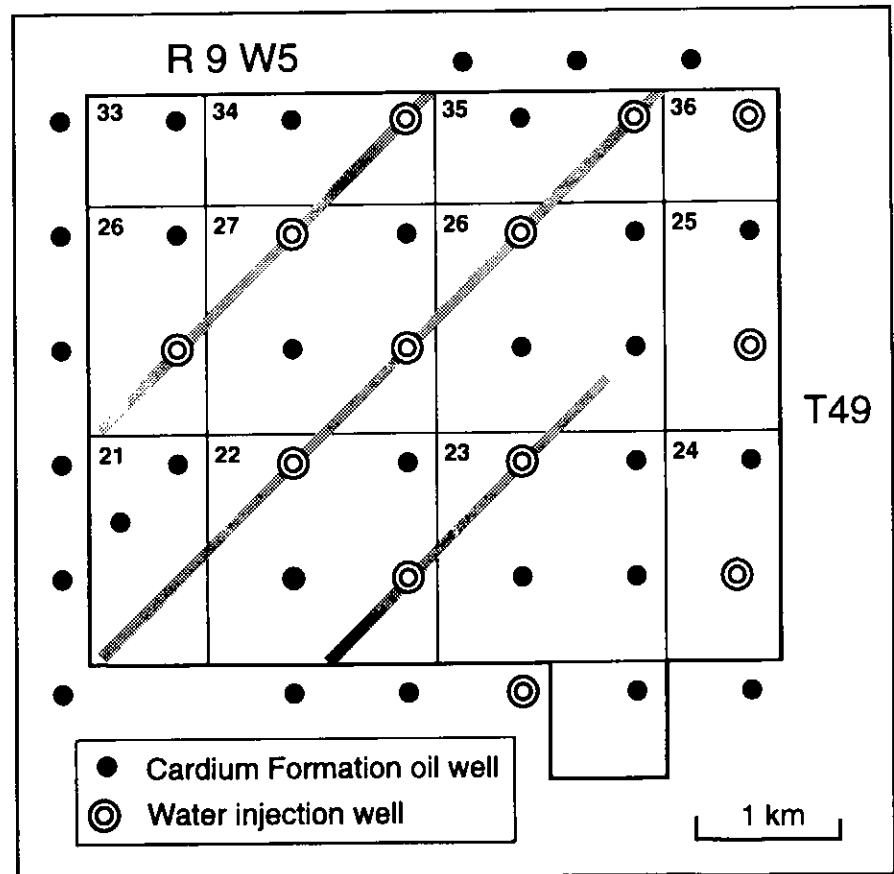

Figure 19 Connections between injection wells drilled to recover oil from the Cretaceous Cardium formation in the Pembina oil field, Alberta (redrawn from McLeod, 1977). Water injected at pressures greater than the overburden load produced hydraulic fractures that propagated to the NE and SW. This is consistent with S_{Hmax} orientations inferred from breakouts in nearby wells.

ersley, Saskatchewan. This compares well with breakouts in neighbouring wells that point to a N40°E orientation for S_{Hmax} (Bell and Babcock, 1986). In some hydrocarbon production operations, water injected to assist in secondary recovery causes hydraulic fracturing which connects one well to another. This has occurred in the Pembina oil field in Alberta (McLeod, 1977; Hassan, 1982) and confirms that S_{Hmax} is oriented at approximately N45°E (Fig. 19), a result fully consistent with breakout data (Bell and Babcock, *op. cit.*).

Drilling-induced Fractures

The widespread use of borehole wall

imaging tools has shown that **drilling-induced fractures** are reasonably common. The most frequently encountered are semi-vertical fractures that are oriented parallel to S_{Hmax} (McCallum and Bell, 1995). It is not clear exactly how these fractures originate. The images imply that they contain drilling mud (Fig. 20) yet, if they are genuine hydraulic fractures, they were not consciously initiated by drilling engineers because the fractures occur in wells where the drilling mudweights have never been raised as high as fracture gradient levels. It is possible that they are brittle fractures which form ahead of the drilling bit due to its weight; in other

words, they represent the outer edges of what would have been centreline fractures had cores been recovered (Lorenz *et al.*, 1990). Alternatively, running in the drillpipe after changing the drill bit can briefly generate pressures high enough to hydraulically fracture rock intervals in a well (Lubunski *et al.*, 1977), so they may be caused by transient pressure surges.

Earthquakes

Stress orientations also can be inferred from earthquakes and, although these events usually are epicentred well below sediments in basins, they can provide useful and relevant information, particularly about the underlying basement (*e.g.*, Lindholm *et al.*, 1995). Occasionally earthquakes are induced by hydrocarbon production activities (Grasso and Wittlinger, 1990; Horner *et al.*, 1994) and, while this may be socially undesirable, such events provide a ready source of intrabasinal stress information, provided enough geophones are deployed to gather it. Earthquakes occur when new or existing fractures experience rapid brittle failure due to differential stress. The resulting displacement (offset along a fault surface) generates compressional waves in the crust (Gough and Gough, 1987). The first arrivals of these waves will be either compressive or rarefactive depending on the spatial relationship of the measurement site to the fault plane's attitude and sense of offset (Fig. 21).

To illustrate how **earthquake focal mechanisms** can provide stress orientation information, Figure 21 has been drawn to depict a map view of an earthquake generated by a sudden left-lateral movement on a pre-existing NE-SW oriented strike-slip fault. Seismic observatories inside the quadrants labelled C received compressive first motions; those inside the quadrants labelled R received initial rarefactions. By convention, the first motions are plotted as "beach ball" diagrams, with the quarter spaces that receive the compressive first arrivals coloured black (Fig. 21). The largest principal stress orientation is contained within the two quarter spaces receiving rarefactive first motions (white areas of the beach balls) and the P axis is the bisector of these two quadrants. However, as Figure 21 emphasizes, the P axis need not correspond exactly to the orientation of S_{Hmax} , and it will not do so unless the

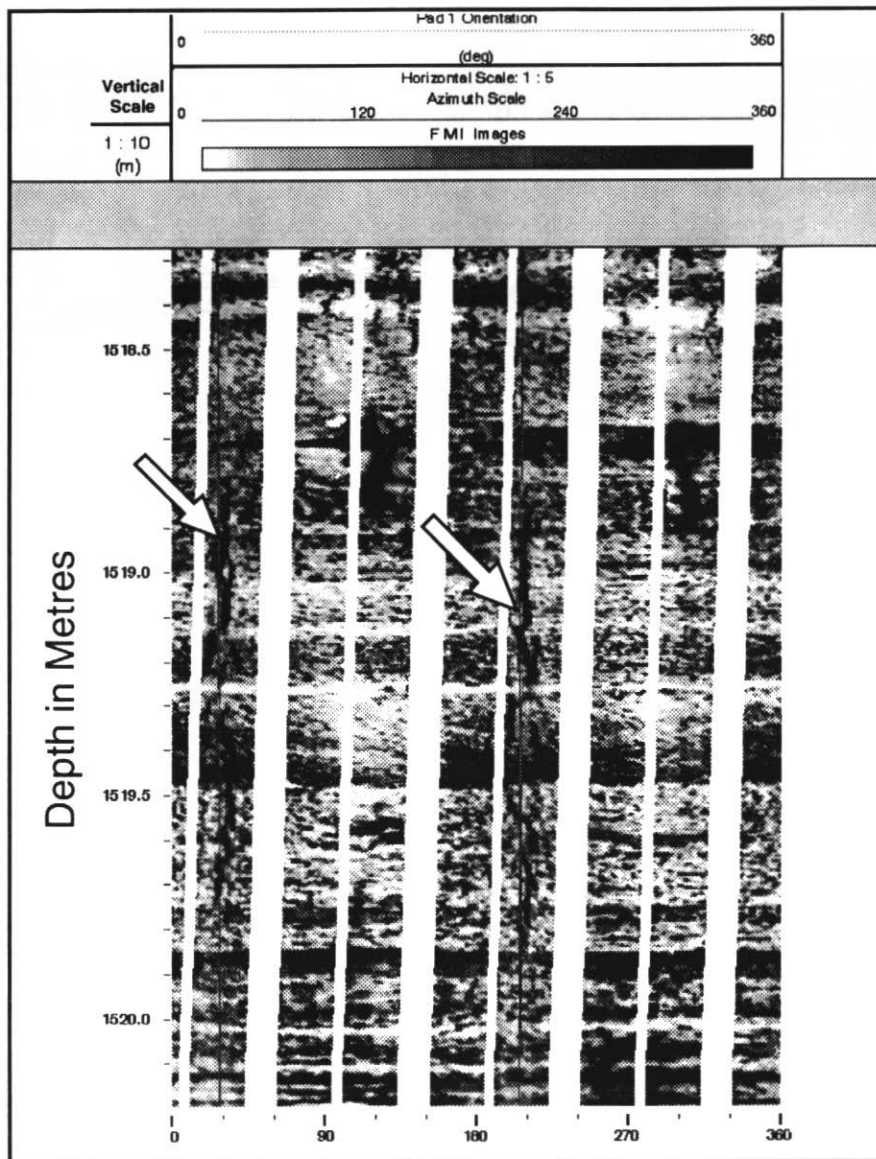

Figure 20 A Formation Micro-imager record from a western Canadian well that shows a semi-vertical drilling-induced fracture intersecting the borehole at N35°E and S215°W (arrows). This orientation coincides closely with S_{Hmax} determined from breakouts in nearby wells.

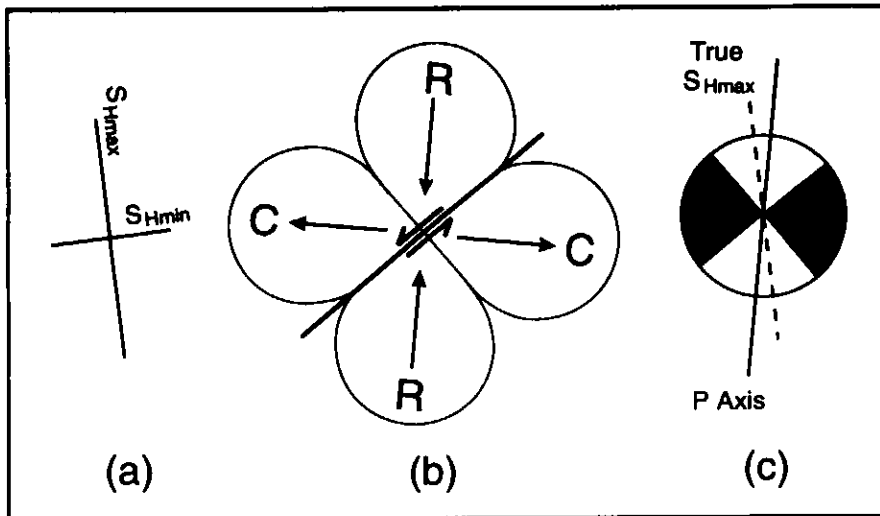

Figure 21 (a) Horizontal principal stress orientations at an earthquake caused by left-lateral strike slip movement on a vertical fault, depicted in map view (b). Quadrants labelled C receive compressive first motions; quadrants labelled R receive rarefractive first motions. The geometry of the first motions is summarized in the "beach ball" figure (c), with the P axis bisecting the two rarefractive quadrants shown in white. In this schematic example the S_{Hmax} orientation lies within the rarefractive quadrants, but does not exactly correspond with the P axis. Earthquake focal mechanisms provide a guide to principal stress directions, but they do not necessarily yield precise orientations.

fault plane involved is a new feature, such as a recently formed subduction zone. In practice, S_{Hmax} is usually within 30° of the P axis orientation (J. Adams, pers. comm., 1995). Averaging P axis orientations from a number of earthquakes in the same province will usually give reasonable regional stress orientations.

CONCLUDING REMARKS

These are the basic techniques and data sources which supply most of the information on *in situ* stresses in sedimentary basins. The challenge is to integrate the measurements so as to characterise stresses in sedimentary basins and to apply the measurements to illuminate and solve significant problems. Applications of stress measurements are discussed in Part II.

REFERENCES

Aadnoy, B.S., 1990, Inversion technique to determine the *in-situ* stresses from fracturing data: *Journal of Petroleum Science and Engineering*, v. 6, n. 4, p. 127-141.
 Adams, J., 1982, Stress-relief buckles in McFarland Quarry, Ottawa: *Canadian Journal of Earth Sciences*, v. 19, p. 1883-1887.

Adams, J., 1995, Canadian Crustal Stress Data Base - a compilation to 1994, Part II: Geological Survey of Canada, Open File Report 3122, 194 p.
 Adams, J. and Bell, J.S., 1991, Crustal stresses in Canada, in Slemmons, D.B., Engdahl, E.R., Zoback, M.D. and Blackwell, D.D. eds., *Neotectonics of North America, Decade Map Volume 1*: Geological Society of America, Boulder, CO, p. 367-386.
 Bell, J.S., 1985, Offset boreholes in the Rocky Mountains of Alberta, Canada: *Geology*, v. 13, p. 734-737.
 Bell, J.S., 1990a, Investigating stress regimes in sedimentary basins using information from oil industry wireline logs and drilling records, in Hurst, A., ed., *Geological Applications of Wireline Logs*: Geological Society of London, Special Publication 48, p. 305-325.
 Bell, J.S., 1990b, The stress regime of the Scotian Shelf, offshore eastern Canada, to 6 kilometers depth and implications for rock mechanics and hydrocarbon migration, in Maury, V. and Fourmaintraux, D., eds., *Rock at Great Depth*, v. 3: Balkema, Rotterdam, The Netherlands, p. 1243-1265.
 Bell, J.S. and Babcock, E.A., 1986, The stress regime of the Western Canadian Basin and implications for hydrocarbon production: *Canadian Petroleum Geology Bulletin*, v. 34, p. 364-378.

Bell, J.S. and Eisbacher, G.H., 1995, Stress orientation indicators (neotectonic plucking fractures) in bedrock of glacier forefields, southeastern Cordillera, western Canada, in *Current Research 1995-B*: Geological Survey of Canada, p. 151-159.
 Bell, J.S. and Eisbacher, G.H., 1996, Neotectonic stress orientation indicators in southwestern British Columbia, in *Current Research 1996-A*: Geological Survey of Canada, p. 143-154.
 Bell, J.S. and McLellan, 1995, Exploration and production implications of subsurface rock stresses in western Canada, in Bell, J.S. and Bird, T.D., eds., *Proceedings of the Oil and Gas Forum '95 - Energy from Sediments*: Geological Survey of Canada, Open File Report 3058, p. 1-5.
 Bell, J.S., Labonté, M. and Courel, R., 1993, How accurately can borehole breakouts record *in-situ* stress orientations? in Haimson, B., ed., *Rock Mechanics in the 1990s, Volume 1: Pre-Print Proceedings of 34th US Symposium on Rock Mechanics*, p. 121-124.
 Bell, J.S., Price, P.R. and McLellan, P.J., 1994, *In-situ stress in the Western Canada Sedimentary Basin*, in Mossop, G.D. and Shetsen, I., compilers, *Geological Atlas of Western Canada Sedimentary Basin: Canadian Society of Petroleum Geologists and Alberta Research Council*, p. 439-446.
 Bock, H.F., 1993, Measuring *in situ* rock stress by borehole slotting, in Hudson, J.A., ed. in chief, *Comprehensive Rock Engineering - Principles, Practice and Projects*: Pergamon Press, v. 3, p. 433-443.
 Breckels, I.M. and Van Eskelen, H.A.M., 1981, Relationship between horizontal stress and depth in sedimentary basins: Paper SPE 10336, 56th Annual Fall Technical Conference, Society of Petroleum Engineers of AIME, 56th Annual Fall Technical Conference, Paper SPE 10336, San Antonio, TX, 5-7 October 1981.
 Cornet, F.H., 1993, The HPTF and the Integrated Stress Determination Methods in Hudson, J.A., ed. in chief, *Comprehensive Rock Engineering - Principles, Practice and Projects*, Pergamon Press, v. 3, p. 413-432.
 Cornet, F.H. and Vallette, B., 1984, *In situ stress determination from hydraulic injection test data*: *Journal of Geophysical Research*, v. 89, p. 11, 527-11, 537.
 Crampin, S., 1978, Seismic wave propagation through a cracked solid: polarisation as a possible dilatancy diagnostic: *Royal Astronomical Society, Geophysical Journal*, v. 53, p. 467-496.
 Daneshy, A.A., Slusher, G.L., Chisholm, P.T. and Magee, D.A., 1986, *In-situ stress measurements during drilling*: *Journal of Petroleum Technology*, August issue, p. 891-898.

- Davis, P.M., 1983, Surface deformation associated with a dipping hydrofracture: *Journal of Geophysical Research*, v. 88, p. 5826-5834.
- Dickey, P.A., 1986, *Petroleum Development Geology, Third Edition*: PennWell Books, Tulsa, OK, 530 p.
- Engelder, T. and Geiser, P.A., 1980, On the use of regional joint sets as trajectories of paleostress fields during the development of the Appalachian Plateau, *New York: Journal of Geophysical Research*, v. 85, p. 6319-6341.
- Fader, G.B.J., 1991, Surficial geology and physical properties 3: subsurface features, in *East Coast Basin Atlas Series: Scotian Shelf: Atlantic Geoscience Centre*, Geological Survey of Canada, p. 115-116.
- Fuller, M., 1969, Magnetic orientation of borehole cores: *Geophysics*, v. 34, p. 772-774.
- Gough, D.I. and Gough, W.I., 1987, Stress near the surface of the Earth: *Annual Review of Earth and Planetary Sciences*, v. 15, p. 545-566.
- Grasso, J-R. and Wittlinger, G., 1990, Ten years of seismic monitoring over a gas field: *Seismological Society of America, Bulletin*, v. 80, n. 2, p. 450-473.
- Haimson, B.C. and Fairhurst, C., 1970, In situ stress determination at great depth by means of hydraulic fracturing, in *Somerton, W., ed., Rock Mechanics - Theory and Practice: American Institute of Mining Engineers, 11th Symposium on Rock-Mechanics, Proceedings*, New York, p. 559-584.
- Haimson, B.C. and Song, I., 1993, Laboratory study of borehole breakouts in Cordova Cream: a case of shear failure mechanism: *International Journal of Rock Mechanics and Mining Sciences & Geomechanical Abstracts*, v. 30, n. 7, p. 1047-1056.
- Hamilton, W.D., Van Alstine, D.R., Butterworth, J.E. and Raham, G., 1995, Paleomagnetic orientation of fractures in the Jean Marie Member Cores from NE British Columbia/NW Alberta: *Petroleum Society of CIM, Annual Technical Meeting, Banff, AB, May 14-17, 1995, Paper 95-56*.
- Hancock, P.L. and Engelder, T., 1989, Neotectonic joints: *Geological Society of America Bulletin*, v. 101, p. 1198-1208.
- Hassan, D., 1982, A method for predicting hydraulic fracture azimuth and the implication thereof to improve hydrocarbon recovery: *Petroleum Society of CIMM, 33rd Annual Technical Meeting, Calgary, June 6-9, 1982, Paper 82-33-19*.
- Heffer, K.J. and Lean, J.C., 1991, Earth stress orientation - a control on, and guide to, flooding directionality in a majority of reservoirs: *Paper presented at the 3rd International Conference on Reservoir Characterisation*, Tulsa, OK.
- Hillis, R.R. and Williams, A.F., 1993, The stress field of the North West Shelf and wellbore stability: *Australian Petroleum Exploration Association, Bulletin*, v. 33, p. 373-385.
- Hoek, E. and Brown, E.T., 1980, *Underground Excavations in Rock*: Institute of Mining and Metallurgy, London, 527 p.
- Horner, R.B., Barclay, J.E. and MacRae, J.M., 1994, Earthquakes and hydrocarbon production in the Fort St. John area, northeastern British Columbia: *Canadian Journal of Exploration Geophysics*, v. 30, n. 1, p. 39-50.
- Hubbert, M.K., and Willis, D.G., 1957, Mechanics of hydraulic fracturing: *AIME Petroleum Transactions*, v. 210, p. 153-166.
- Kirsch, V., 1898, Die Theorie der Elastizität und die Bedürfnisse der Festigkeitslehre: *Zeitschrift des Vereines Deutscher Ingenieure*, Nr. 29, 16 July, 1998, p. 797-807.
- Kry, P.R. and Gronseth, J.M., 1983, In-situ stresses and hydraulic fracturing in the Deep Basin: *Journal of Canadian Petroleum Technology*, v. 22, n. 6, p. 31-35.
- Kulander, B.R., Dean, S.L. and Ward, B.J., 1990, Fractured core analysis: Interpretation, Logging, and Use of Natural and Induced Fractures in Core: *Methods in Exploration Series, n. 8: American Association of Petroleum Geologists*, 88 p.
- Kunze, K.R. and Steiger, R.P., 1992, Accurate in-situ stress measurements during drilling operations: *Society of Petroleum Engineers, 67th Annual Technical Conference and Exhibition, Proceedings, Paper 24593*, p. 491-499.
- Lindholm, C.D., Bungum, H., Bratli, R.K., Aadnoy, B.S., Dahl, H., Torudbakken, B. and Atakan, K., 1995, Crustal stress in the northern North Sea as inferred from borehole breakouts and earthquake focal mechanisms: *Terra Nova*, v. 7, p. 51-59.
- Lorenz, J.C., Finley, S.J. and Warpinski, N.R., 1990, Significance of coring-induced fractures in Mesaverde Core, Northwest Colorado: *American Association of Petroleum Geologists, Bulletin*, v. 74, p. 1017-1029.
- Lorenz, J.C., Teufel, L.W. and Warpinski, N.R., 1991, Regional fractures 1: A mechanism for the formation of regional fractures at depth in flat-lying reservoirs: *American Association of Petroleum Geologists, Bulletin*, v. 75, p. 1714-1737.
- Lubinski, A., Hsu, F.H. and Nolte, K.G., 1977, Transient pressure surges due to pipe movement in an oil well: *Revue de l'Institut Français du Pétrole*, May-June 1977, p. 307-342.
- Mastin, L., 1988, Effect of borehole deviation on breakout orientations: *Journal of Geophysical Research*, v. 93, p. 9187-9195.
- Maury, V., 1991, The role of rock mechanics in oil and gas exploration: *Nature, Supplement*, v. 350, 18 April 1991, p. 8-10.
- Maury, V., Santarelli, F.J. and Henry, J.P., 1988, Core discing: a review: 1st African Conference on Rock Mechanics, Swaziland, *Proceedings*.
- McCallum R.E. and Bell, J.S., 1995, Diagnosing natural and drilling-induced fractures from borehole images of Western Canadian wells, in *Bell, J.S. and Bird, T.D., eds., Proceedings of the Oil and Gas Forum '95 - Energy from Sediments: Geological Survey of Canada, Open File Report 3058*, p. 79-82.
- McGarr, A. and Gay, N.C., 1978, State of stress in the Earth's crust: *Earth and Planetary Sciences, Annual Review*, v. 6, p. 405-436.
- McLeod, J.G. F., 1977, Successful injection pattern alteration, Pembina J Lease, Alberta: *Petroleum Society of CIMM, Paper presented at 28th Annual Meeting*, Edmonton, AB.
- Meinardus, H.W., Jasek, N.A., Grisak, G.E. and Saulnier, G.J., Jr., 1993, Offset shot-holes in west Texas: evidence for neotectonics, stress relief, or blasting phenomenon?: *Association of Engineering Geologists, Bulletin*, v. 30, p. 427-442.
- Moos, D. and Zoback, M.D., 1990, Utilization of observations of well bore failure to constrain the orientation and magnitude of crustal stresses: Application to continental, deep sea drilling project, and ocean drilling program boreholes: *Journal of Geophysical Research*, v. 95, p. 9305-9325.
- Mount, V.S. and Suppe, J., 1987, State of stress near the San Andreas fault: Implications for wrench tectonics: *Geology*, v. 15, p. 1143-1146.
- Nolte, K.G., 1988a, Principles for fracture design based on pressure analysis: *SPE Production Engineering*, February 1988, p. 22-31.
- Nolte, K.G., 1988b, Application of Fracture Design based on Pressure Analysis: *SPE Production Engineering*, February 1988, p. 31-42.
- Obert, L. and Stephenson, D.E., 1965, Stress conditions under which core discing occurs: *Society of Mining Engineers, Transactions*, v. 232, p. 227-235.
- Paillet, F.L. and Kim, K., 1987, Character and distribution of borehole breakouts and their relationship to in situ stresses in deep Columbia River basalts: *Journal of Geophysical Research*, v. 92, p. 6223-6234.
- Parker, D.L. and Heffernan, P.D., 1992, Methods of determining induced fracture orientation - Ferrier field application: *Canadian Well Logging Society, Journal*, v. 18, p. 7-22.

- Peska, P. and Zoback, M.D., 1995, Observations of borehole breakouts and tensile wall-fractures in deviated boreholes: A technique to constrain in situ stress and rock strength, *in* Daemen, J.J.K. and Schultz R.A., eds., *Rock Mechanics: 35th US Symposium*, Balkema, Rotterdam, The Netherlands, Proceedings, p. 319-325.
- Pollard, D.D. and Holzhausen, G.R., 1979, On the mechanical interaction between a fluid-filled fracture and the earth's surface: *Tectonophysics*, v. 53, p. 27-57.
- Plumb, R.A. and Cox, J.W., 1987, Stress directions in eastern North America determined to 4.5 km from borehole elongation measurements: *Journal of Geophysical Research*, v. 92, p. 4805-4816.
- Rathore, J., Fjaer, E., Renlie, L. and Nysæther, J., 1993, Estimation of phase velocities in cracked rocks: *European Association of Exploration Geophysicists, 55th Meeting and Technical Exhibition, Stavanger, Norway, 7-11 June 1993, Extended Abstracts, Paper P124*.
- Talebi, S., Young, R.P., Vandamme, L. and McGaughey, W.J., 1991, Microseismic mapping of a hydraulic fracture, *in* Roegiers, J.P., ed., *Rock Mechanics as a Multidisciplinary Science*: Balkema, Rotterdam, The Netherlands, p. 461-470.
- Tan, C.P., Willoughby, D.R., Zhou, S. and Hillis R.R., 1993, An analytical method for determining horizontal stress bounds from wellbore data: *International Journal of Rock Mechanics and Mining Sciences and Geomechanics, Abstracts*, v. 30, n. 7, p. 1103-1109.
- Wallach, J., Benn, K. and Rimando, R., 1995, Recent, tectonically induced, surficial stress-relief structures in the Ottawa-Hull area, Canada: *Canadian Journal of Earth Sciences*, v. 32, p. 325-333.
- Warpinski, N.R., Teufel, L.W., Lorenz, J.C. and Holcomb, D.J., 1993, *Core-based Stress Measurements: A Guide to their Application*: Gas Research Institute, Topical Report n. GRI-93/0270, 140 p.
- Yassir, N.A. and Bell, J.S., 1996, Abnormally high fluid pressures and associated porosities and stress regimes in sedimentary basins: *SPE Formation Evaluation*, v. 11, n. 1, p. 5-10.
- Zoback, M.D., Moos, D., Mastin, L. and Anderson, R.N., 1985, Wellbore breakouts and in-situ stress: *Journal of Geophysical Research*, v. 90, p. 5523-5530.
- Zoback, M.L. and 28 others, 1989, Global patterns of tectonic stress: *Nature*, v. 341, p. 291-298.